

1

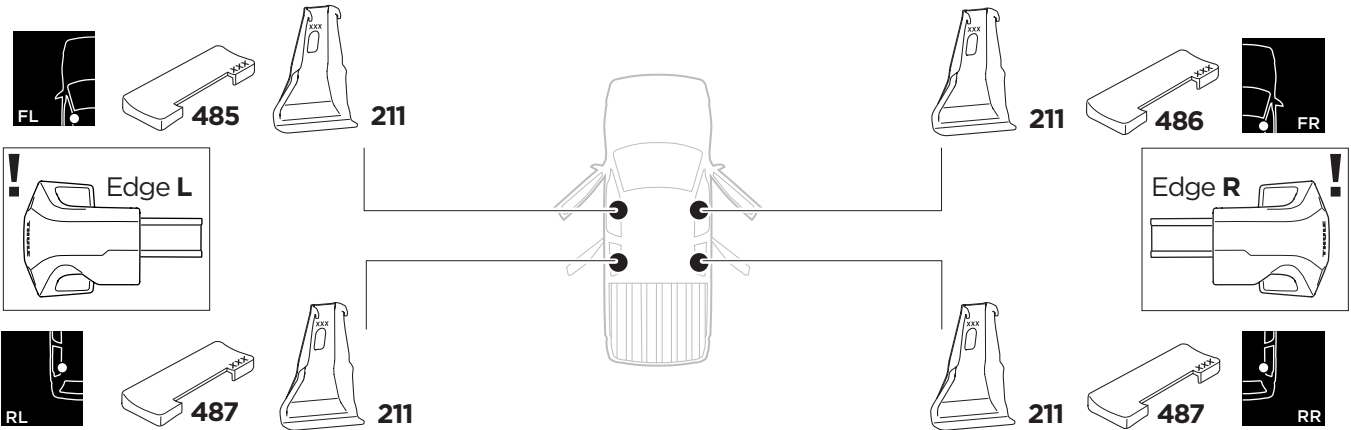

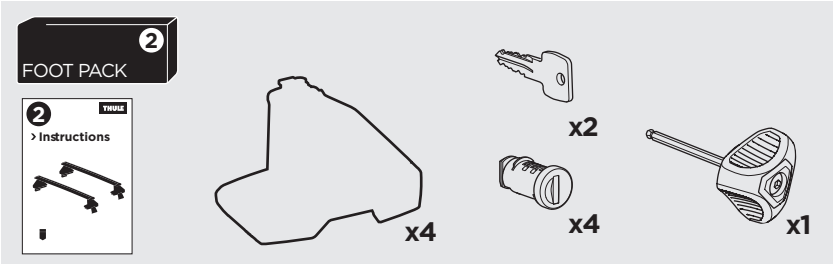

Kit 145063

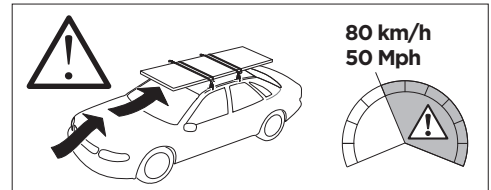
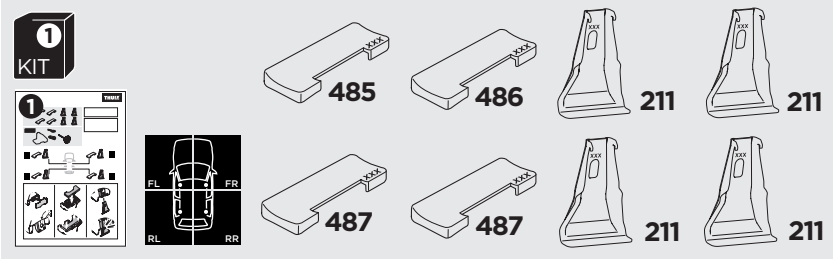

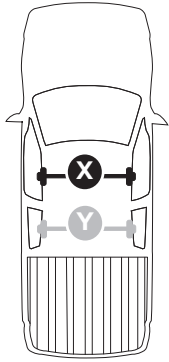
FORD Ranger, 4-dr Double Cab, 11-
 FORD Ranger, 4-dr Super Cab, 11-
 MAZDA BT-50, 4-dr Double Cab, 12-
 MAZDA BT-50, 2-dr Single Cab, 12-

ISO 11154-E









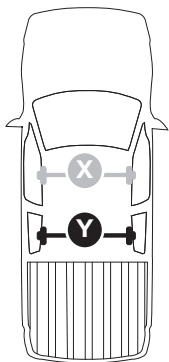

 THULE WingBar Evo  THULE WingBar Edge  THULE WingBar  THULE SquareBar Evo	Evo X (scale)	Edge X (scale)
FORD Ranger , 4-dr Double Cab, 11-	47	C
FORD Ranger , 4-dr Super Cab, 11-	47	C
MAZDA BT-50 , 4-dr Double Cab Cab, 12-	47	C
MAZDA BT-50 , 2-dr Single Cab Cab, 12-	47	C

 THULE ProBar Evo  THULE SlideBar Evo	X (mm/inch)
FORD Ranger , 4-dr Double Cab, 11-	1121 mm / 44 1/8"
FORD Ranger , 4-dr Super Cab, 11-	1121 mm / 44 1/8"
MAZDA BT-50 , 4-dr Double Cab, 12-	1121 mm / 44 1/8"
MAZDA BT-50 , 2-dr Single Cab, 12-	1121 mm / 44 1/8"



 THULE WingBar Evo  THULE WingBar Edge  THULE WingBar  THULE SquareBar Evo	Evo Y (scale)	Edge Y (scale)
FORD Ranger , 4-dr Double Cab, 11-	45	G
FORD Ranger , 4-dr Super Cab, 11-	44,5	H
MAZDA BT-50 , 4-dr Double Cab, 12-	44,5	H
MAZDA BT-50 , 2-dr Single Cab, 12-	-	-

 THULE ProBar Evo  THULE SlideBar Evo	Y (mm/inch)
FORD Ranger , 4-dr Double Cab, 11-	1101 mm / 43 3/8"
FORD Ranger , 4-dr Super Cab, 11-	1096 mm / 43 1/8"
MAZDA BT-50 , 4-dr Double Cab, 12-	1096 mm / 43 1/8"
MAZDA BT-50 , 2-dr Single Cab, 12-	-

	W (mm/inch)	Z (mm/inch)
FORD Ranger , 4-dr Double Cab, 11-	700 mm / 27 1/2"	235 mm / 9 1/4"
FORD Ranger , 4-dr Super Cab, 11-	600 mm / 23 5/8"	185 mm / 7 1/4"
MAZDA BT-50 , 4-dr Double Cab, 12-	600 mm / 23 5/8"	185 mm / 7 1/4"
MAZDA BT-50 , 2-dr Single Cab, 12-	-	185 mm / 7 1/4"

